

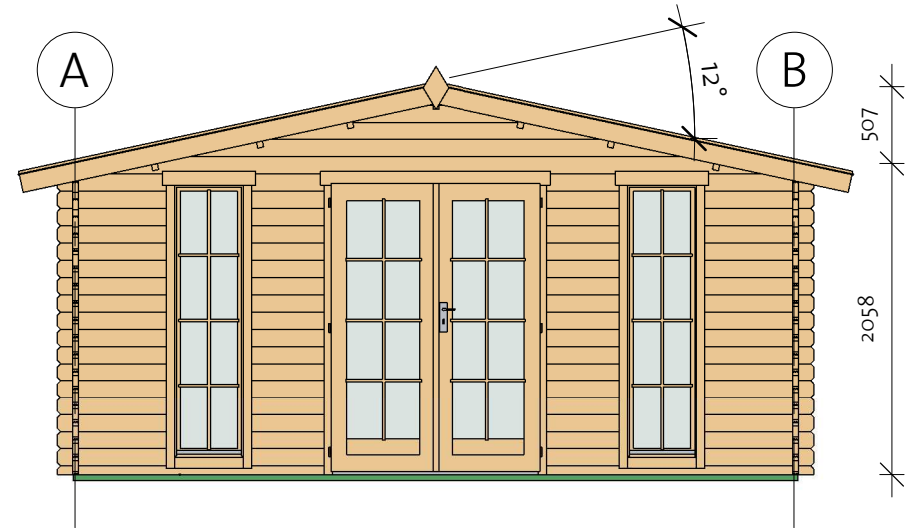

Lybeck 40 (480x360)

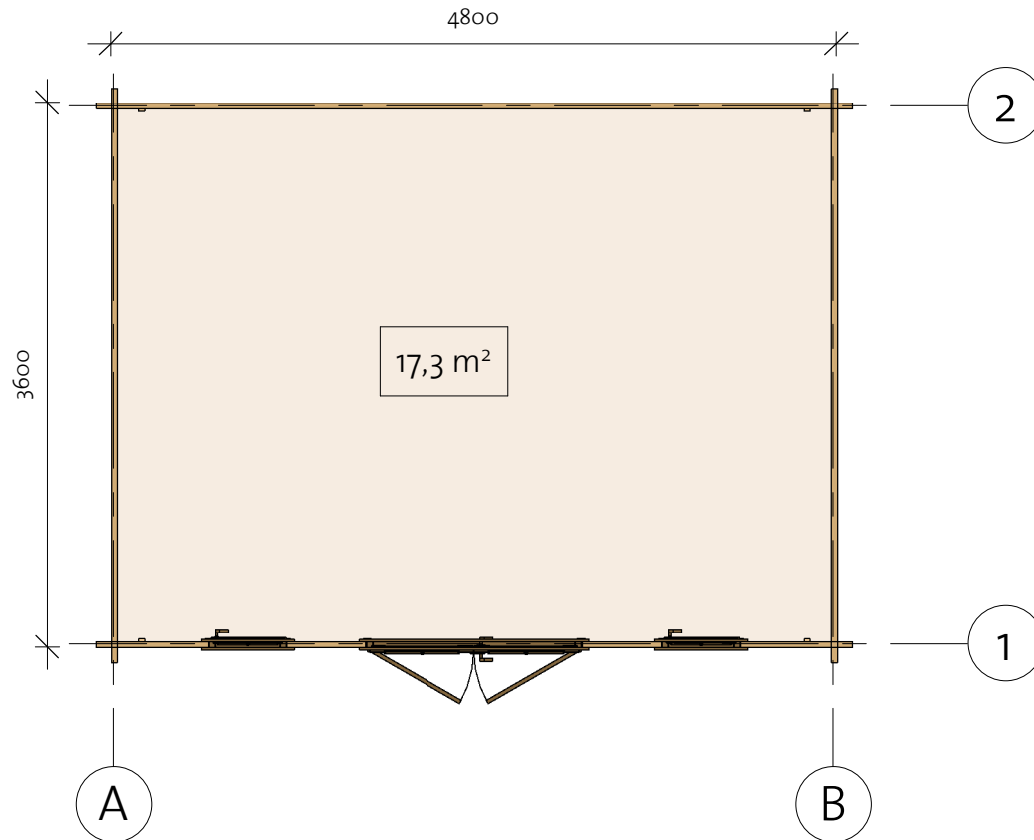

Lybeck 40 (480x360)

Foundation

| Impregnated foundation beams | | | | |
|------------------------------|--------------|---|-------|--------|
| Mark | Type | Profile | Count | Length |
| IFB | IFB 70x40 |  | 7 | 4790 |





Lybeck 40 (480x360)

Floor Plan

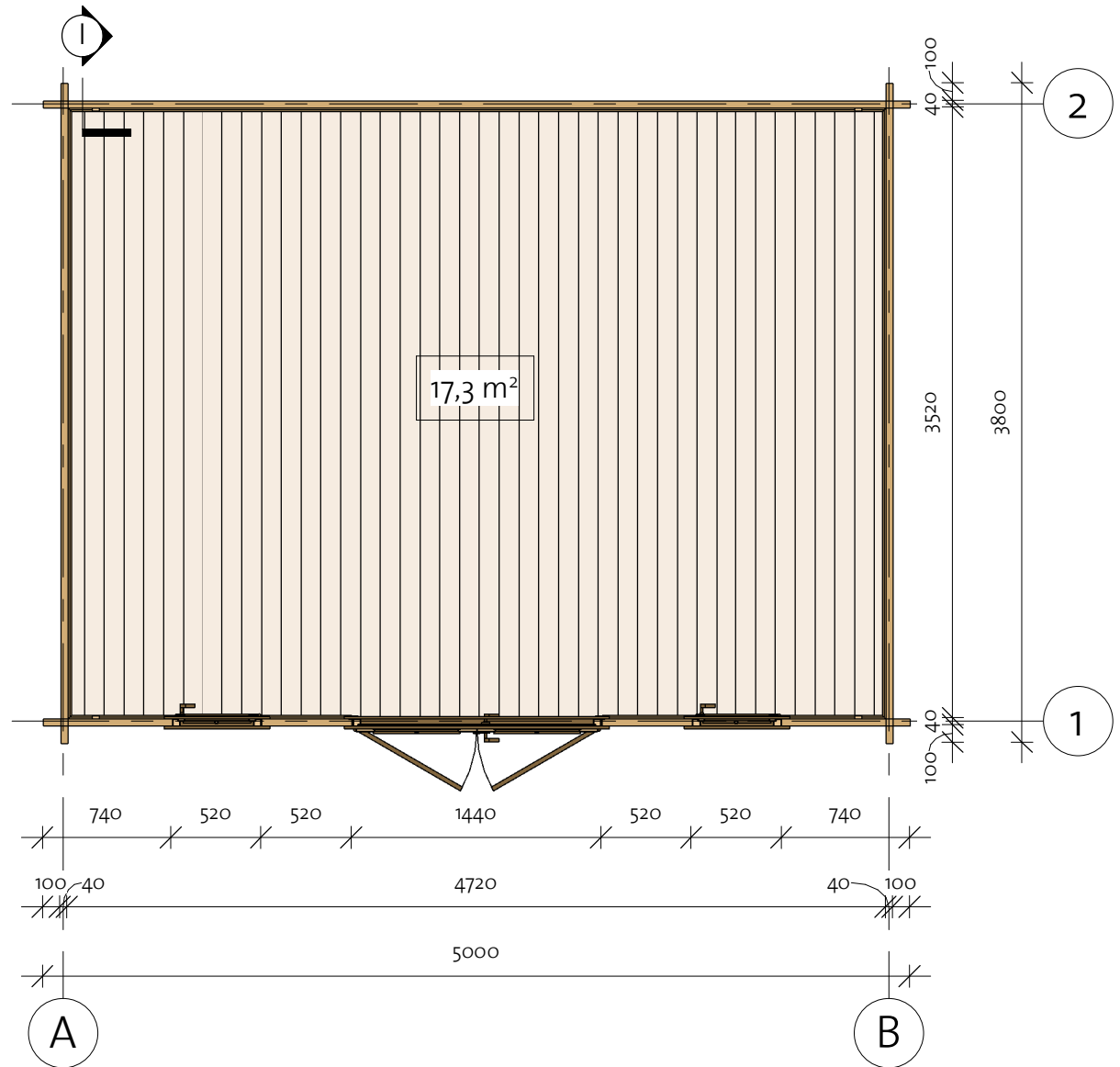
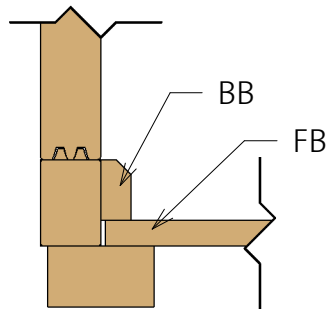
I Baseboard



Floor Schedule

| Mark | Type | Profile | Count | Length |
|------|-----------|---|-------|--------|
| FB | FB 17x114 |  | 43 | 3517 |
| BB1 | BB 20x40 |  | 2 | 3600 |
| BB2 | BB 20x40 | | 2 | 4800 |

92001061_221109

Lybeck 40 (480x360)

Wall 1

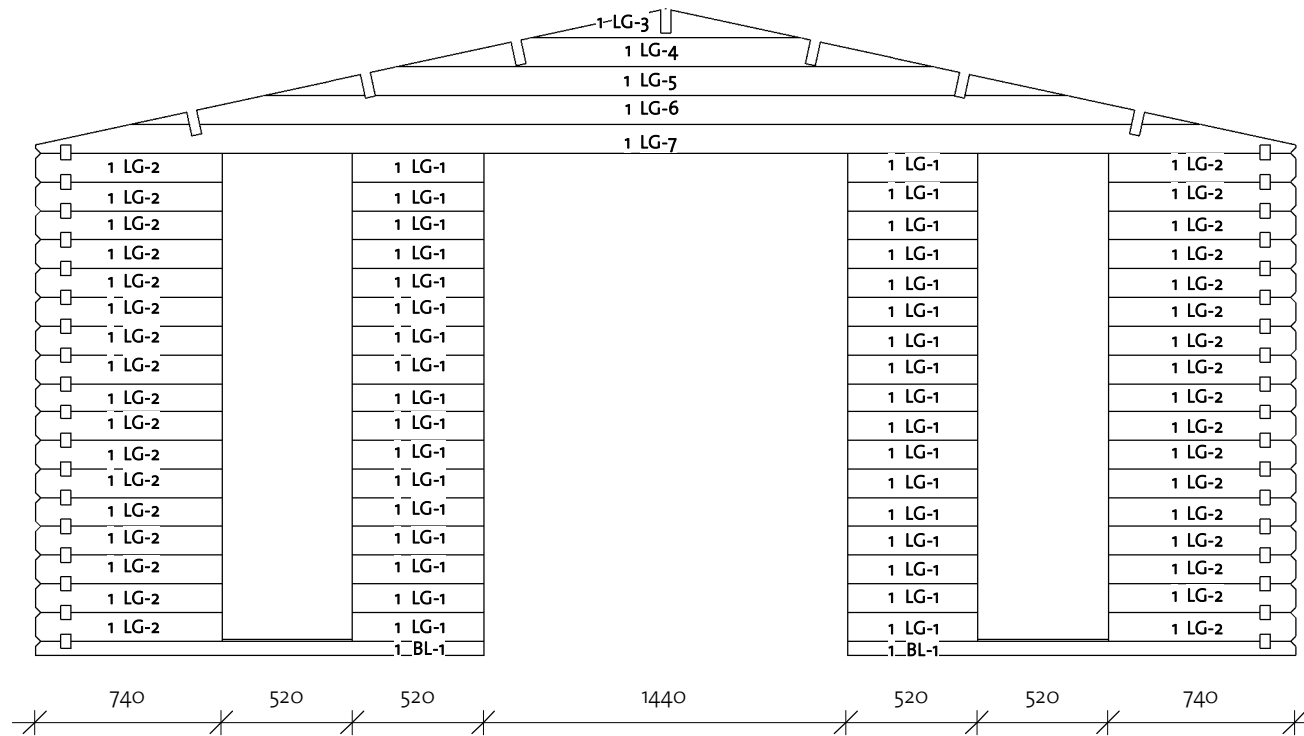
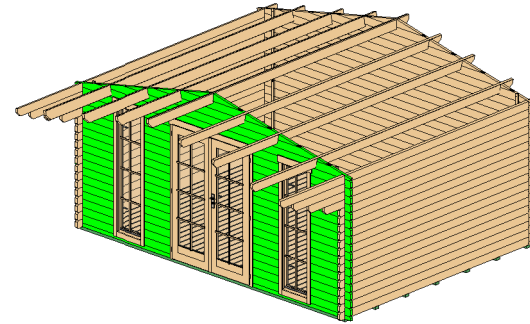

| Wall 1 | | | |
|--------|---------|-------|------------|
| Mark | Profile | Count | Cut Length |

| | | | |
|--------|--------|----|------|
| 1BL-1 | 40x57 | 2 | 1780 |
| 1LG-1 | 40x114 | 34 | 520 |
| 1LG-2 | 40x114 | 34 | 740 |
| 1LG-3* | 40x114 | 1 | 1064 |
| 1LG-4* | 40x114 | 1 | 2124 |
| 1LG-5* | 40x114 | 1 | 3185 |
| 1LG-6* | 40x114 | 1 | 4246 |
| 1LG-7* | 40x114 | 1 | 5000 |

* Gable - delivered premounted

| Log Profile Wall 1 | |
|--------------------|---------|
| Profile | Profile |

| | |
|--------|--|
| 40x57 | |
| 40x114 | |

Lybeck 40 (480x360)

Wall B

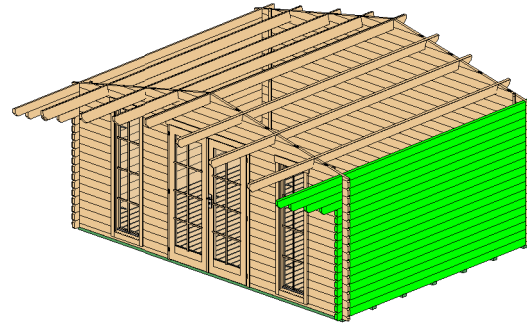

| Wall B | | | |
|--------|---------|-------|------------|
| Mark | Profile | Count | Cut Length |

| | | | |
|-------|--------|----|------|
| BLG-1 | 40x114 | 14 | 3800 |
| BLG-2 | 40x114 | 1 | 4100 |
| BLG-3 | 40x114 | 1 | 4400 |
| BLG-4 | 40x114 | 1 | 4700 |
| BTL-1 | 40x120 | 1 | 5050 |

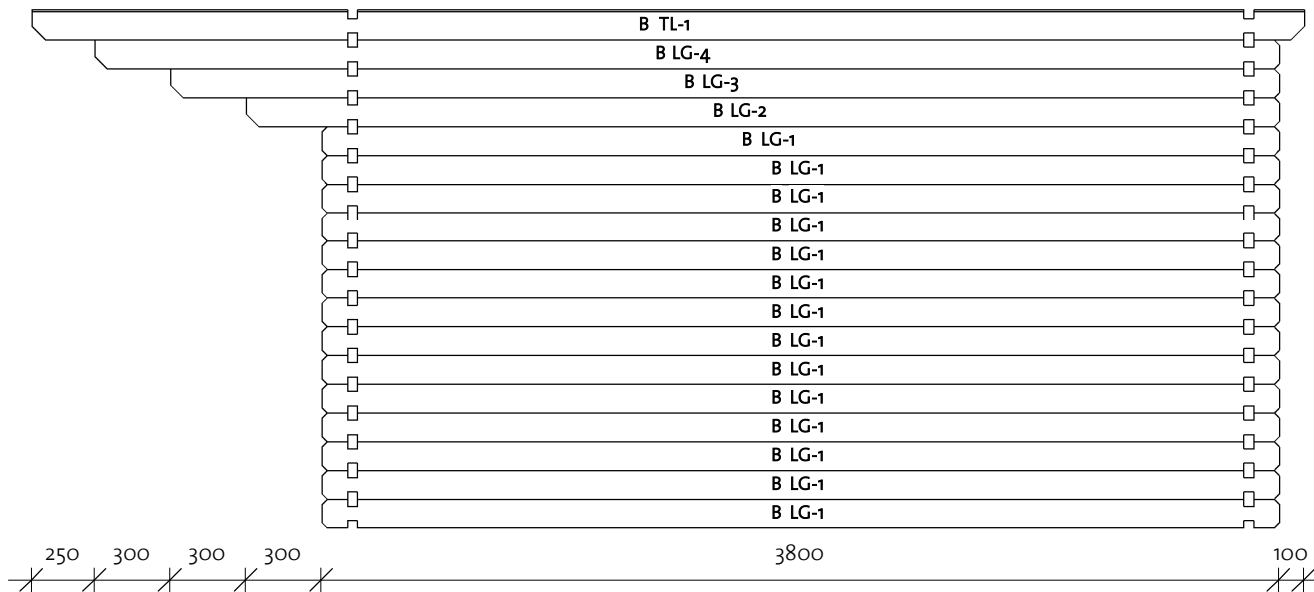





| Log Profile Wall B | |
|--------------------|---------|
| Profile | Profile |

| | |
|--------|--|
| 40X114 | |
| 40X120 | |

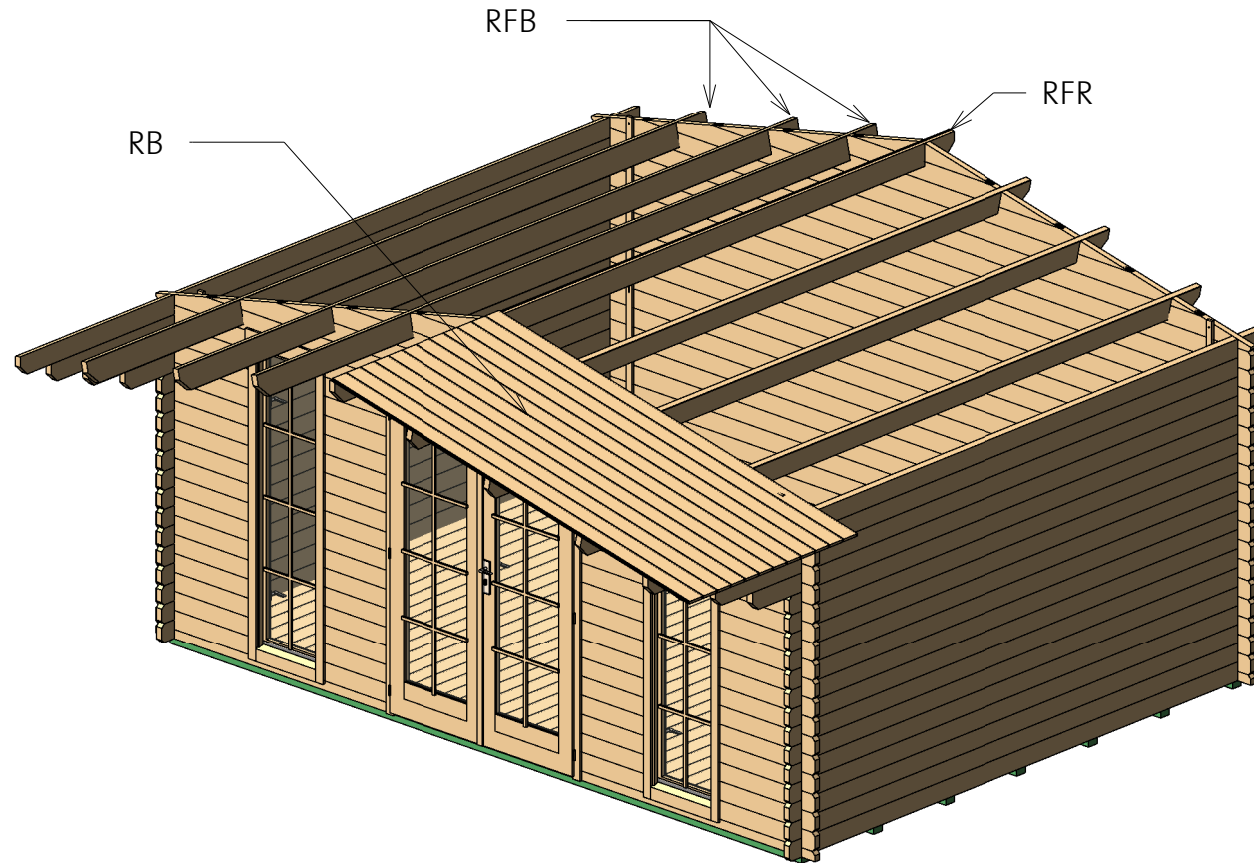
Lybeck 40 (480x360)

Roof 1



| Roof | | | | |
|------|-----------------|---|-------|--------|
| Mark | Type | Profile | Count | Length |
| RFR | Ridge 40x143 |  | 1 | 5050 |
| RFB | Beam 40x143 |  | 6 | 5050 |
| RB | 17x114 |  | 92 | 2775 |

Lybeck 40 (480x360)



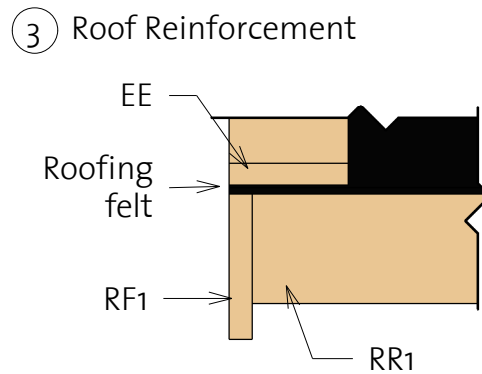
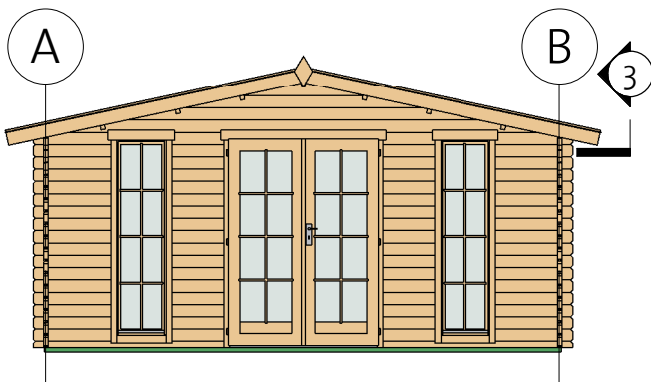
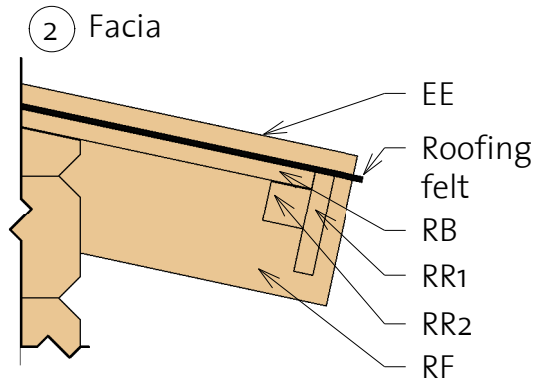
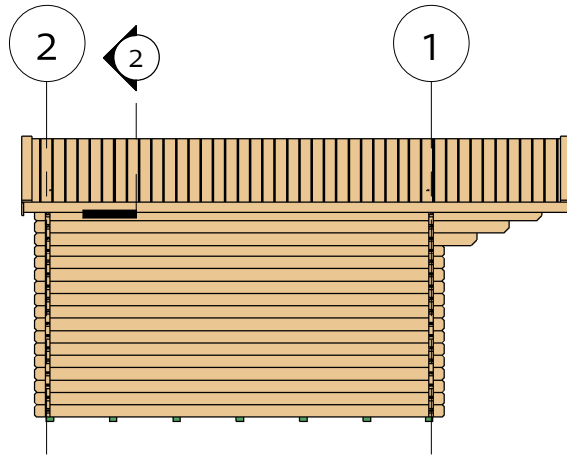



























Roof 2



| Fascia Schedule | | | | |
|-----------------|-----------------------------|---------|-------|--------|
| Mark | Type | Profile | Count | Length |
| EE | Eave Edging 18x95 | | 4 | 2815 |
| RF | Roof Fascia 18x120 | | 4 | 2815 |
| RR1 | Roof reinforcement 18x95 | | 2 | 5050 |
| RR2 | Roof reinforcement 38x38 | | 2 | 5050 |

Lybeck 40 (480x360)

List of all items 1

| | | | | | | |
|-----|----------|--|--|---|----|------|
| | RFB | Beam 40x143 |  |  | 6 | 5050 |
| | RFR | Ridge 40x143 |  |  | 1 | 5050 |
| A | TL-1 | Log 40x120 |  |  | 1 | 5050 |
| B | TL-1 | Log 40x120 |  |  | 1 | 5050 |
| 2 | BL-1 | Log 40x57 |  | | 1 | 5000 |
| 2 | LG-5 | Log 40x114 |  | | 17 | 5000 |
| | IFB | IFB 70x40 |  |  | 7 | 4790 |
| A | LG-4 | Log 40x114 |  | | 1 | 4700 |
| B | LG-4 | Log 40x114 |  | | 1 | 4700 |
| A | LG-3 | Log 40x114 |  | | 1 | 4400 |
| B | LG-3 | Log 40x114 |  | | 1 | 4400 |
| A | LG-2 | Log 40x114 |  | | 1 | 4100 |
| B | LG-2 | Log 40x114 |  | | 1 | 4100 |
| A | LG-1 | Log 40x114 |  | | 14 | 3800 |
| B | LG-1 | Log 40x114 |  | | 14 | 3800 |
| | FB | FB 17x114 |  |  | 43 | 3517 |
| | RB | 17x114 |  |  | 92 | 2775 |
| 1 | BL-1 | Log 40x57 |  | | 2 | 1780 |
| 1 | LG-2 | Log 40x114 |  | | 34 | 740 |
| 1 | LG-1 | Log 40x114 |  | | 34 | 520 |
| BB1 | BB 20x40 |  | |  | 2 | 3600 |
| BB2 | BB 20x40 |  | |  | 2 | 4800 |

Lybeck 40 (480x360)



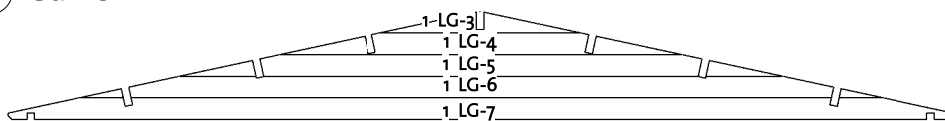

List of all items 2

① Gable 1

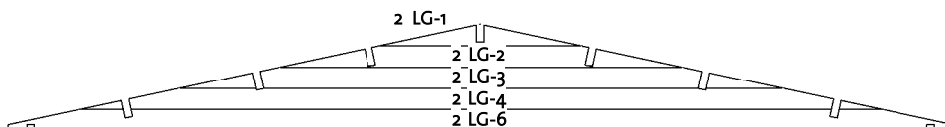

② Gable 2



| | | | | |
|-----|-----------------------------|--|---|------|
| RR1 | Roof reinforcement 18x95 |  | 2 | 5050 |
| RR2 | Roof reinforcement 38x38 |  | 2 | 5050 |
| EE | Eave Edging 18x95 |  | 4 | 2815 |
| RF | Roof Fascia 18x120 |  | 4 | 2815 |

| | | | |
|-----------------|---|---|------|
| Windboard 18x40 |  | 4 | 2200 |
|-----------------|---|---|------|

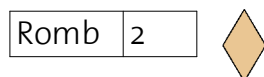

| | | | | |
|-------|--------------------------------|------|------|---|
| CDD3R | Classic double door 3 right | 1425 | 1955 | 1 |
|-------|--------------------------------|------|------|---|

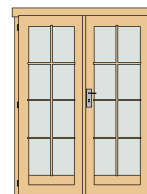





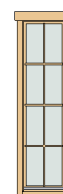

| | | | | |
|------|-----------------|----|----|---|
| DCB8 | Door Crossbar 8 | -- | -- | 2 |
|------|-----------------|----|----|---|

| | | | | |
|-------|----------------------------|-----|------|---|
| CW21R | Classic window 21 right | 515 | 1890 | 2 |
|-------|----------------------------|-----|------|---|



| | | | | |
|------|------------------|----|----|---|
| WCB8 | Windows Crossbar | -- | -- | 2 |
|------|------------------|----|----|---|

- * Windows intended for tilt opening only!
- * Fenster zur Eröffnung nur zum Kippen vorgesehen!
- * Aknad on ette nähtud ainult kaldu avamiseks!

| | | | |
|----------|------------|---|-----|
| Hitblock | 300-400 mm |  | |
| Bolts | M8 x 70 |  | 12 |
| Screws | 5,0 x 70 |  | 25 |
| Nails | 1,4 x 40 |  | 30 |
| Screws | 6,0 x 140 |  | 50 |
| Screws | 4,0 x 40 |  | 970 |

Windboard

① Windboard Assembly 1



② Windboard Assembly 2

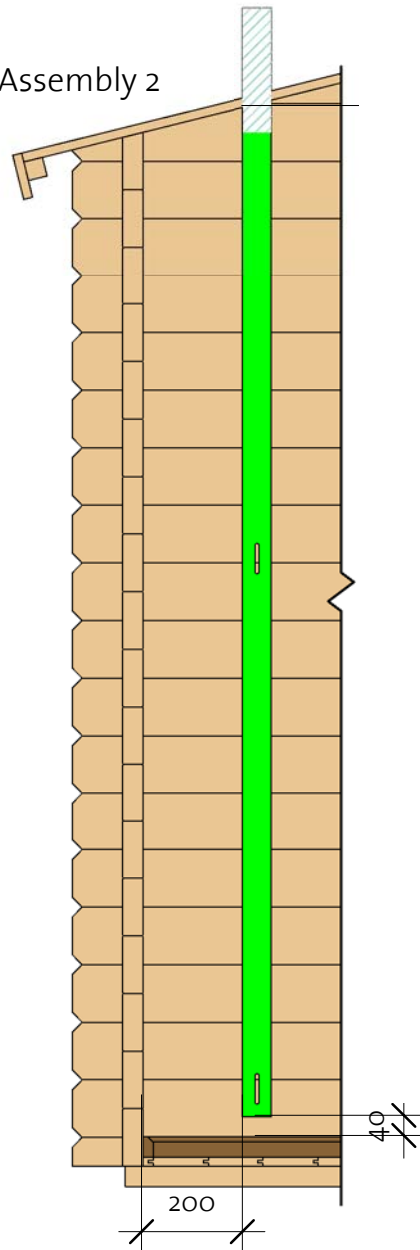

③ Windboard Assembly 3

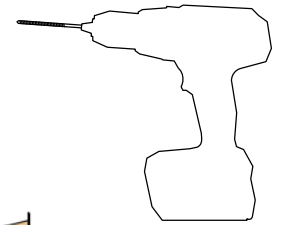
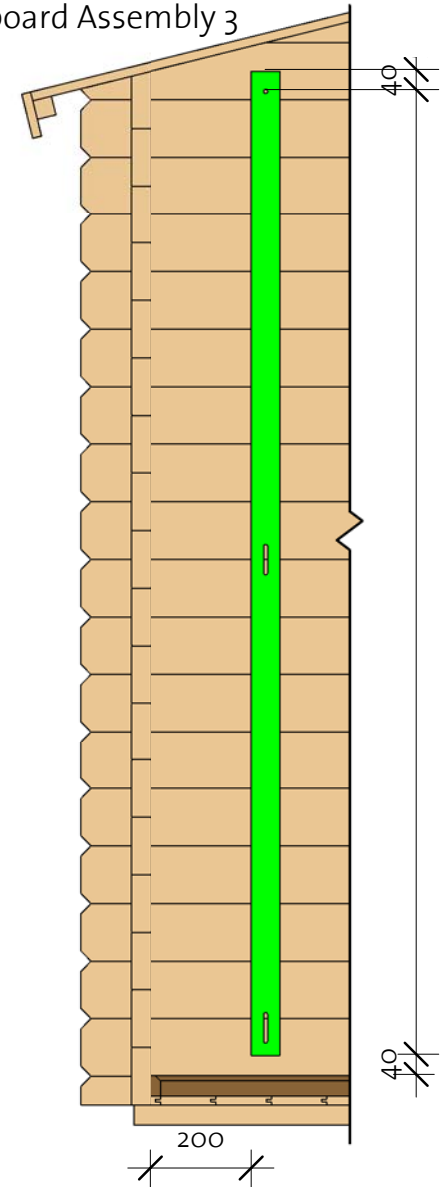

Ø 8mm